



me
SHEETS

- SPECIFICATION GUIDELINES
- INSTALLATION GUIDELINES

BY WOOD-SKIN®



mesh SHEETS

Mesh sheets is a new way to design curvy and smooth surfaces from flat sheets. This fantastic technology unlocks the design potential of flat and rigid surfaces, allowing the construction of elegant membranes with the same functional properties and look-and-feel of “macro-tissues”.



TENSIONING SYSTEM

ANCHORING POINT

CLASSIC A



S

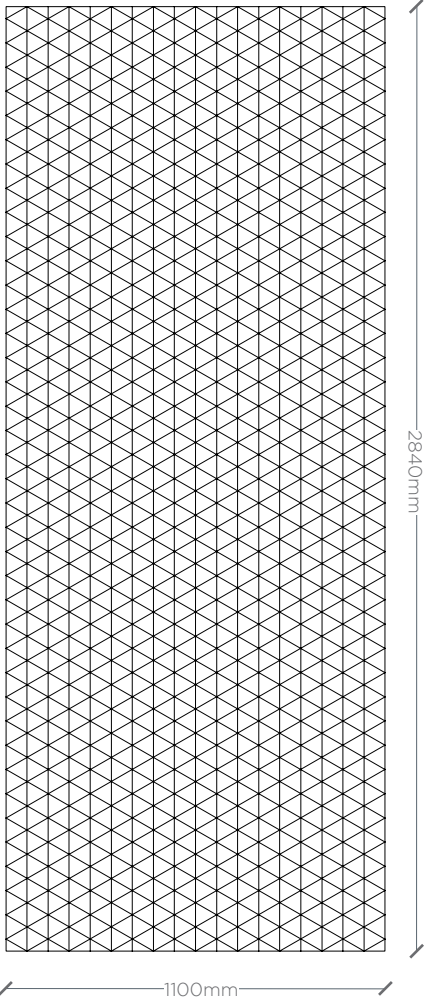

M

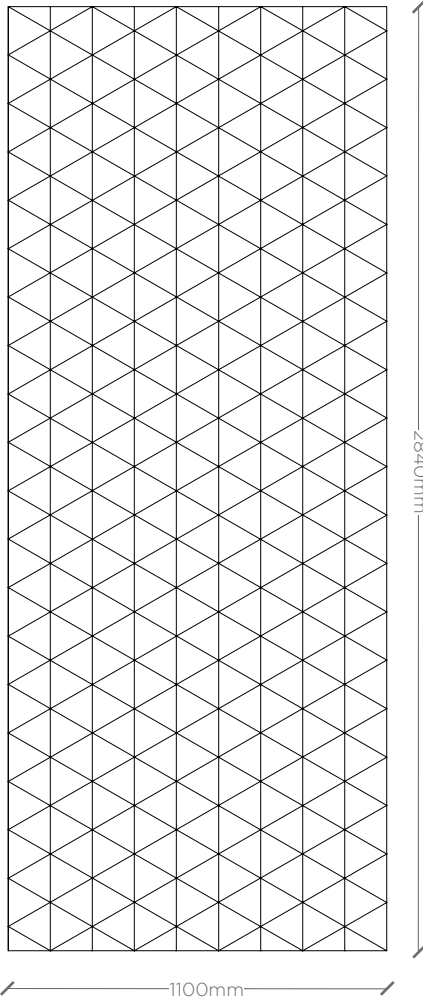



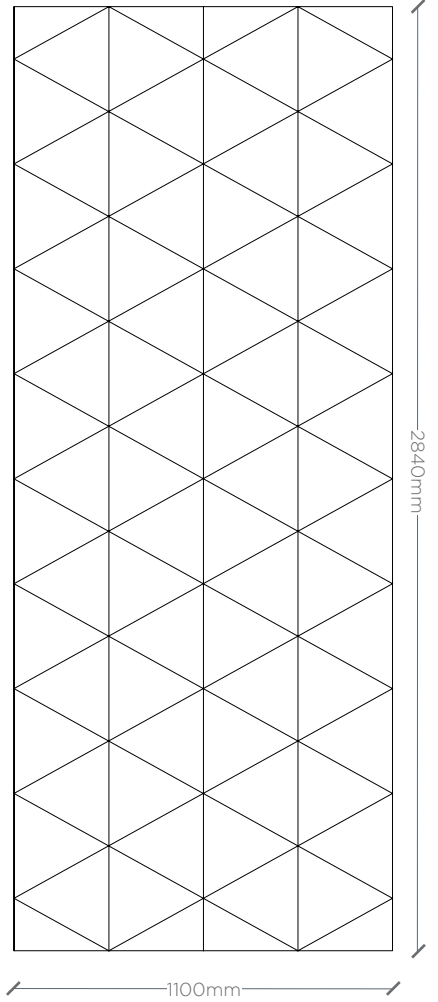

L





AVAILABLE MATERIALS

-  OKUMÉ
-  MDF COLOR

-  ULTRA MATT LAMINATE
-  ULTRA THIN RECONSTITUTED WOOD

-  BIRCH
-  OKUMÉ
-  MDF COLOR

-  ULTRA MATT LAMINATE
-  ULTRA THIN RECONSTITUTED WOOD
-  SYNTHETIC FELT

-  BIRCH
-  OKUMÉ
-  MDF COLOR

-  ULTRA MATT LAMINATE
-  ULTRA THIN RECONSTITUTED WOOD
-  SYNTHETIC FELT

CLASSIC B



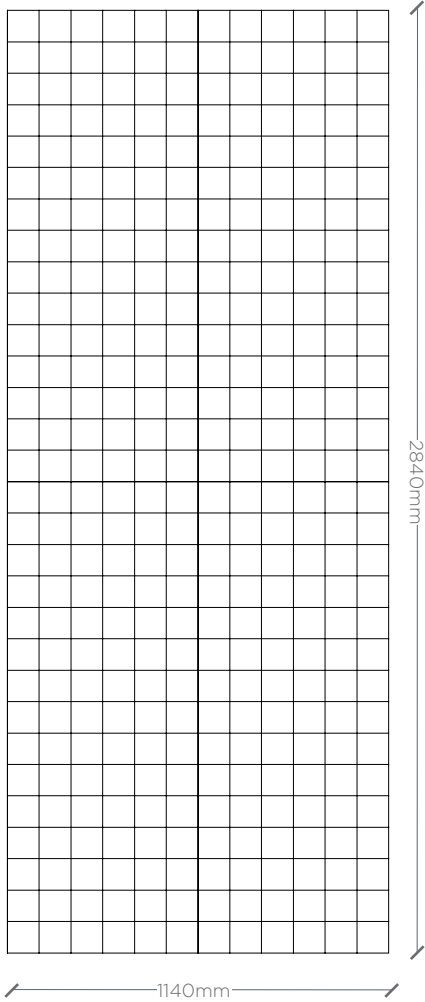

M



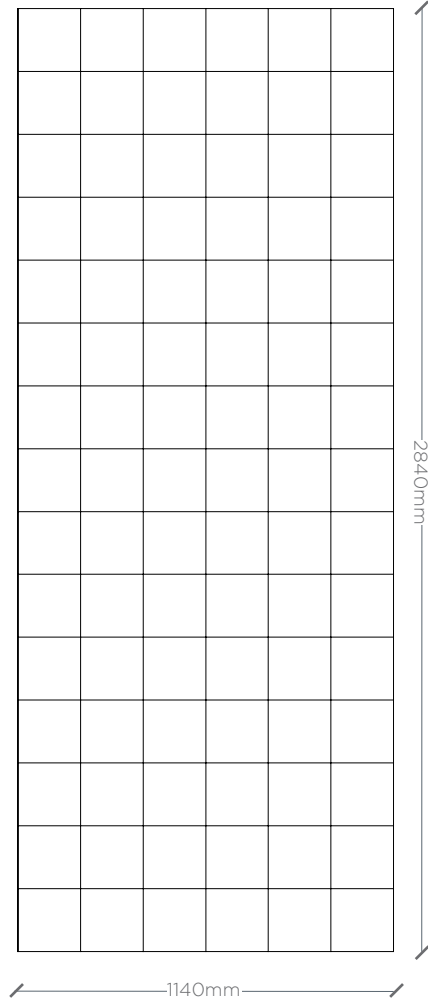

L



AVAILABLE MATERIALS

-  BIRCH
-  OKUMÈ
-  MDF COLOR

-  ULTRA MATT LAMINATE
-  ULTRA THIN RECONSTITUTED WOOD
-  SYNTHETIC FELT

-  BIRCH
-  OKUMÈ
-  MDF COLOR

-  ULTRA MATT LAMINATE
-  ULTRA THIN RECONSTITUTED WOOD
-  SYNTHETIC FELT

CLASSIC C



S

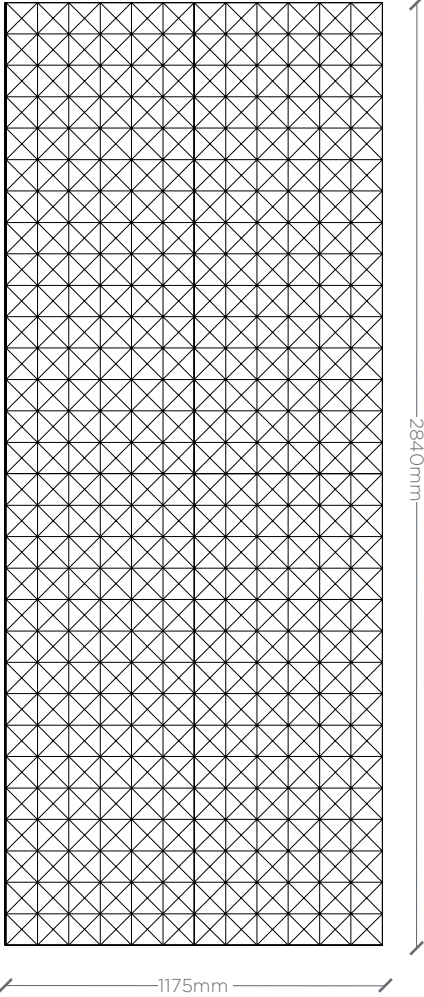

M

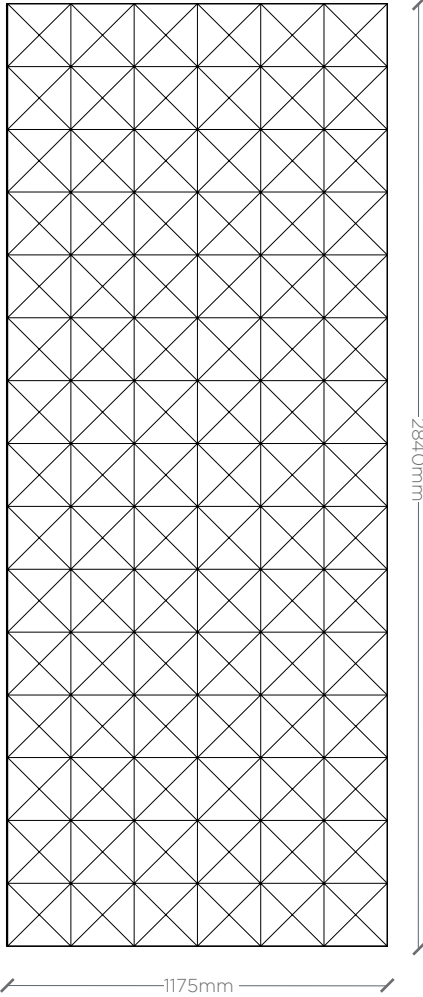

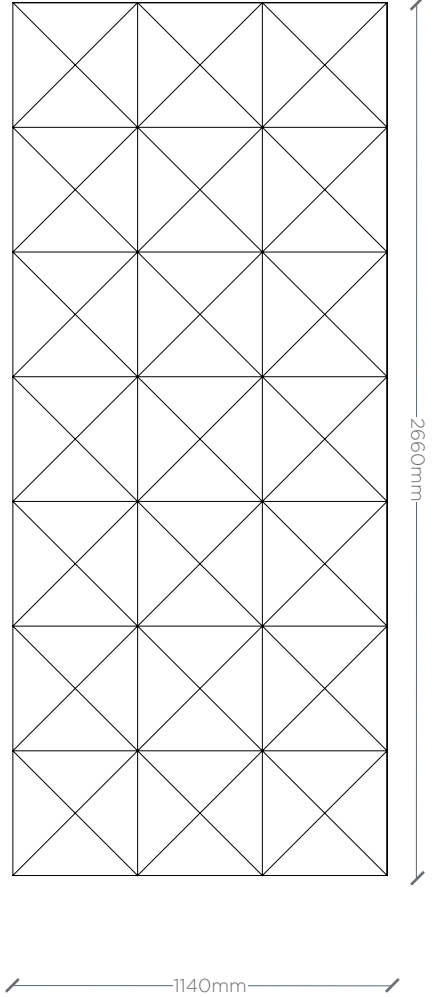

L





AVAILABLE MATERIALS

-  OKUMÉ
-  MDF COLOR

-  ULTRA MATT LAMINATE
-  ULTRA THIN RECONSTITUTED WOOD

-  BIRCH
-  OKUMÉ
-  MDF COLOR

-  ULTRA MATT LAMINATE
-  ULTRA THIN RECONSTITUTED WOOD
-  SYNTHETIC FELT

-  BIRCH
-  OKUMÉ
-  MDF COLOR

-  ULTRA MATT LAMINATE
-  ULTRA THIN RECONSTITUTED WOOD
-  SYNTHETIC FELT

BASIC A



S

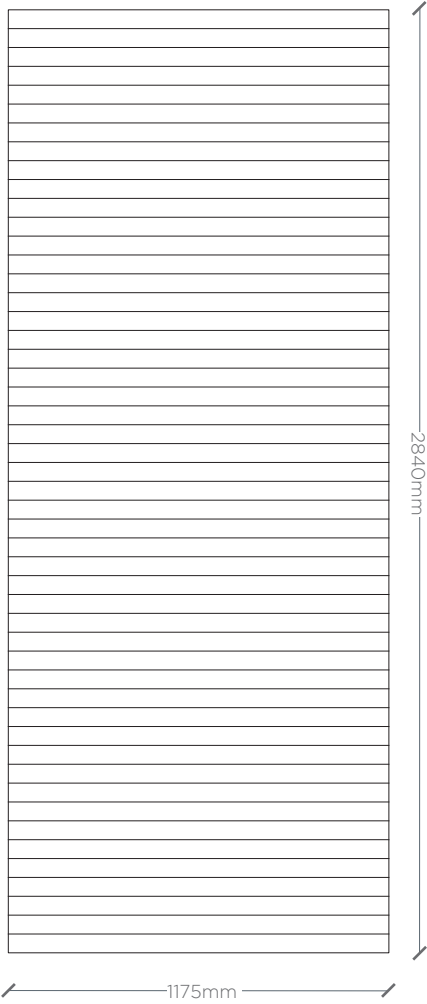

M

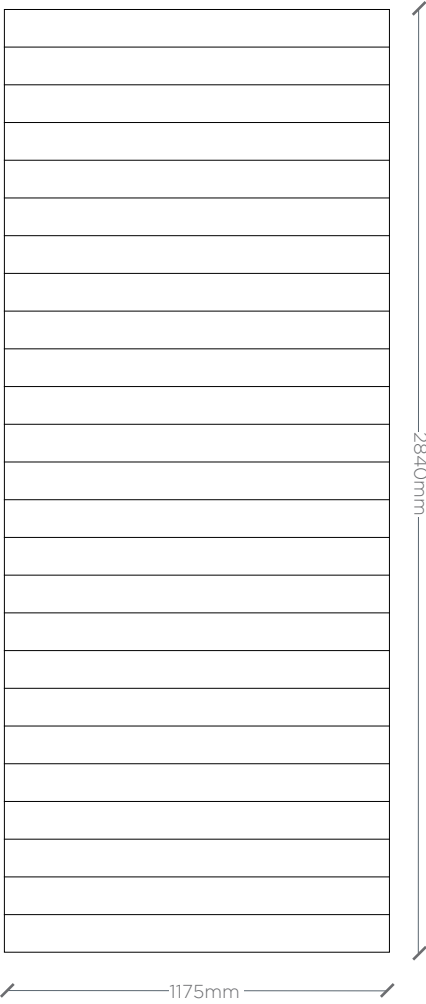



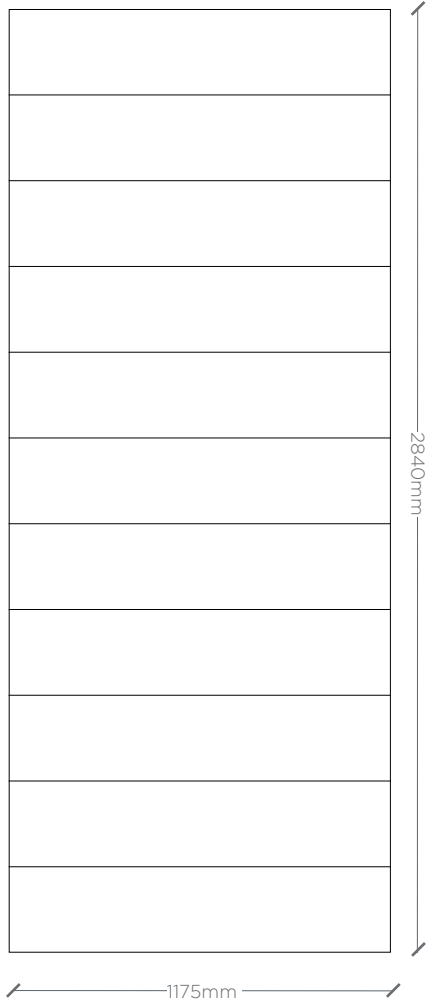

L





AVAILABLE MATERIALS

-  OKUMÈ
-  MDF COLOR

-  ULTRA MATT LAMINATE
-  ULTRA THIN RECONSTITUTED WOOD

-  BIRCH
-  OKUMÈ
-  MDF COLOR

-  ULTRA MATT LAMINATE
-  ULTRA THIN RECONSTITUTED WOOD
-  SYNTHETIC FELT



-  BIRCH
-  OKUMÈ
-  MDF COLOR

-  ULTRA MATT LAMINATE
-  ULTRA THIN RECONSTITUTED WOOD
-  SYNTHETIC FELT

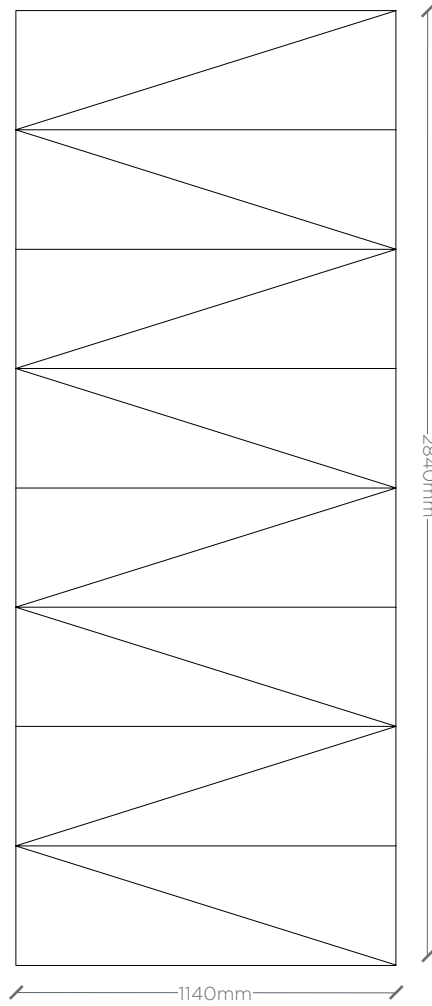
M



AVAILABLE MATERIALS

-  BIRCH
-  OKUMÉ
-  MDF COLOR

-  ULTRA MATT LAMINATE
-  ULTRA THIN RECONSTITUTED WOOD
-  SYNTHETIC FELT



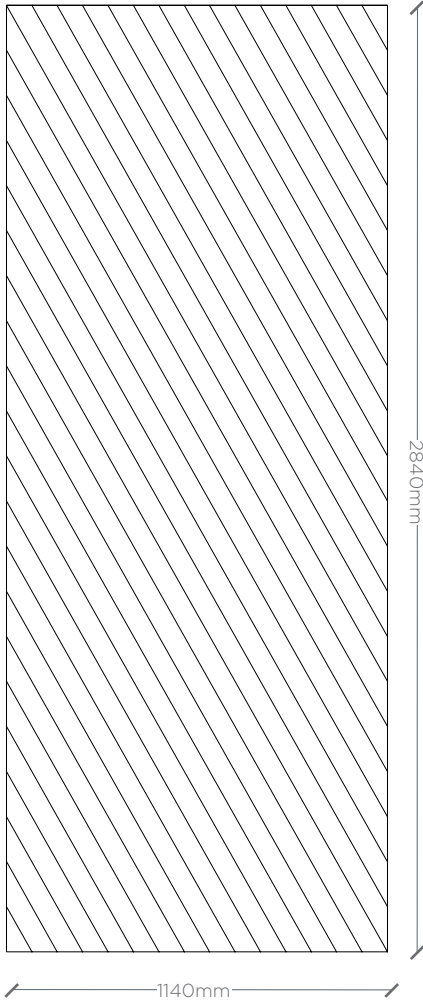

M



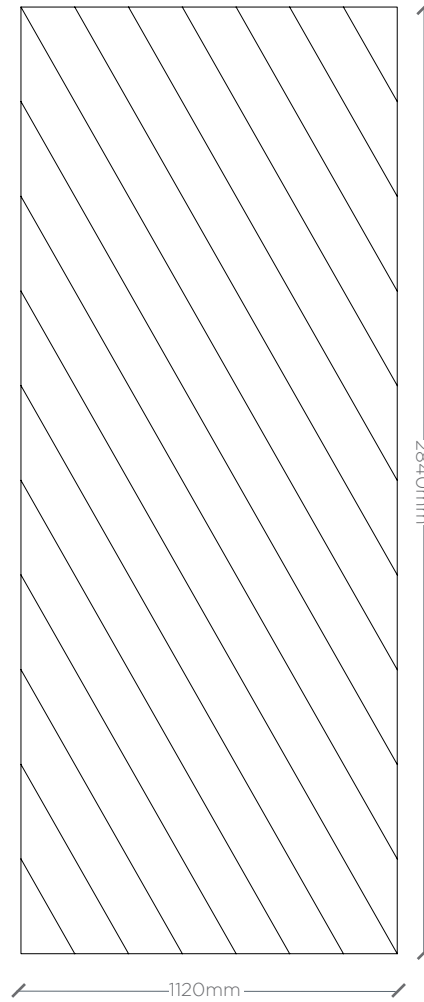

L



AVAILABLE MATERIALS

-  BIRCH
-  OKUMÈ
-  MDF COLOR

-  ULTRA MATT LAMINATE
-  ULTRA THIN RECONSTITUTED WOOD
-  SYNTHETIC FELT

-  BIRCH
-  OKUMÈ
-  MDF COLOR

-  ULTRA MATT LAMINATE
-  ULTRA THIN RECONSTITUTED WOOD
-  SYNTHETIC FELT



M

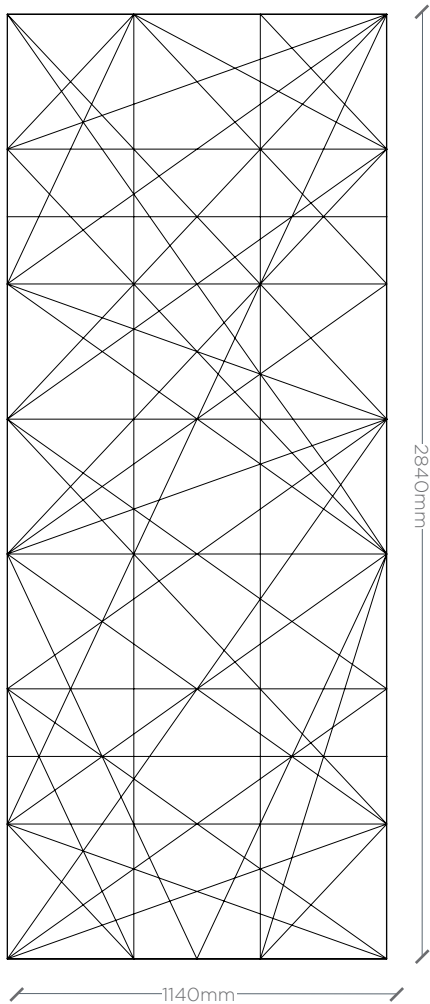

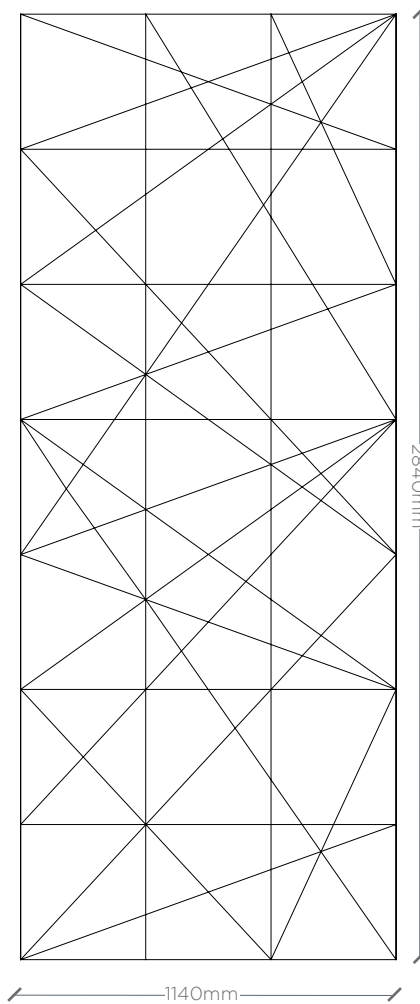

L



AVAILABLE MATERIALS

-  ULTRA MATT LAMINATE
-  ULTRA THIN RECONSTITUTED WOOD

-  ULTRA MATT LAMINATE
-  ULTRA THIN RECONSTITUTED WOOD



S

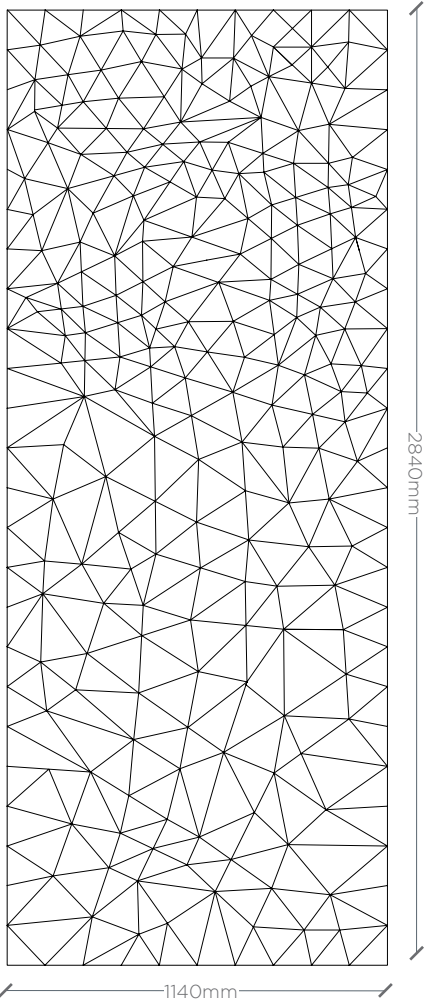

M

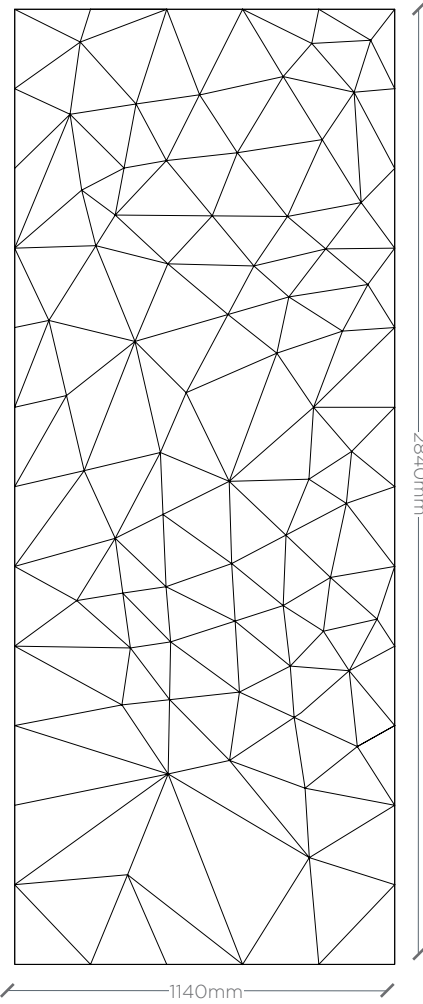

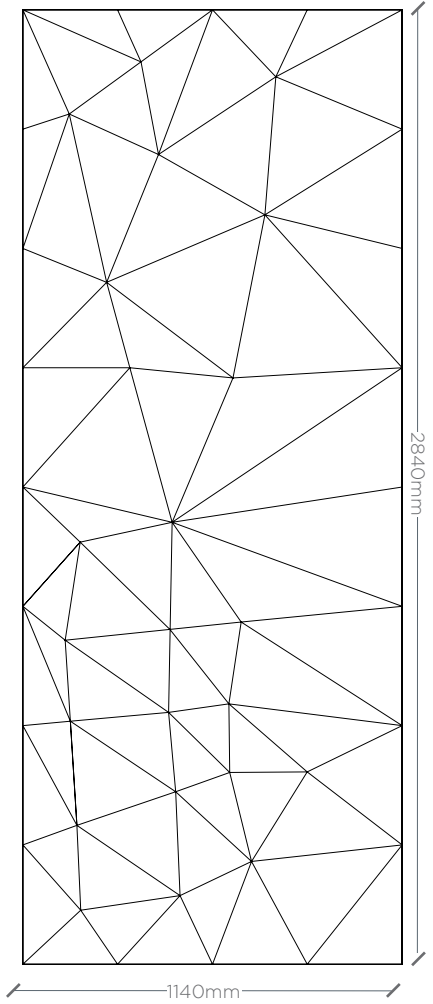

L





AVAILABLE MATERIALS

-  ULTRA MATT LAMINATE
-  ULTRA THIN RECONSTITUTED WOOD

-  BIRCH
-  OKUMÉ
-  MDF COLOR

-  ULTRA MATT LAMINATE
-  ULTRA THIN RECONSTITUTED WOOD
-  SYNTHETIC FELT

-  BIRCH
-  OKUMÉ
-  MDF COLOR

-  ULTRA MATT LAMINATE
-  ULTRA THIN RECONSTITUTED WOOD
-  SYNTHETIC FELT



S

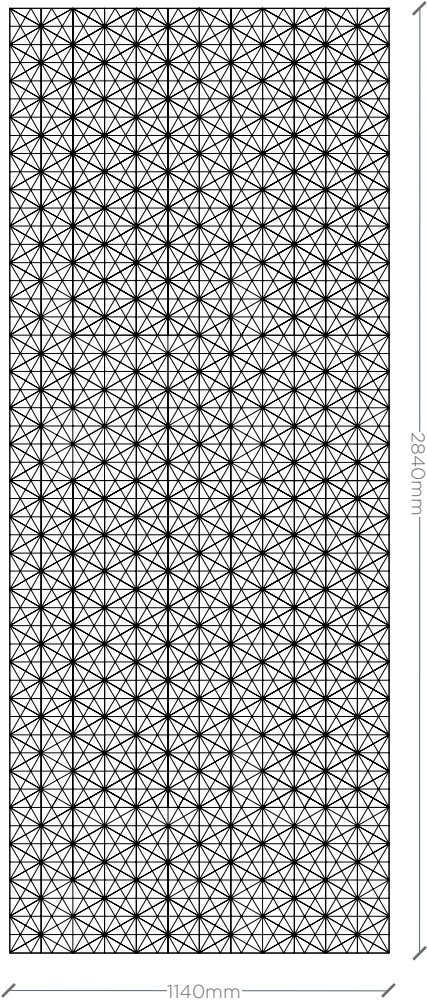

M

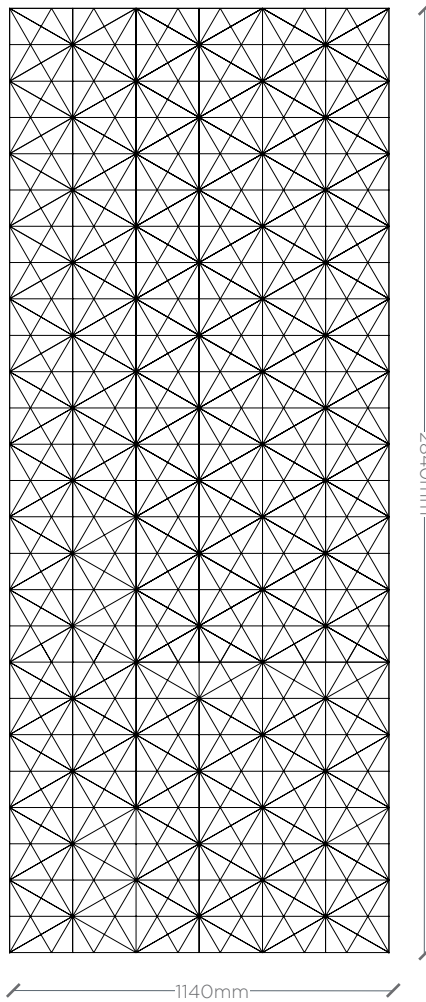

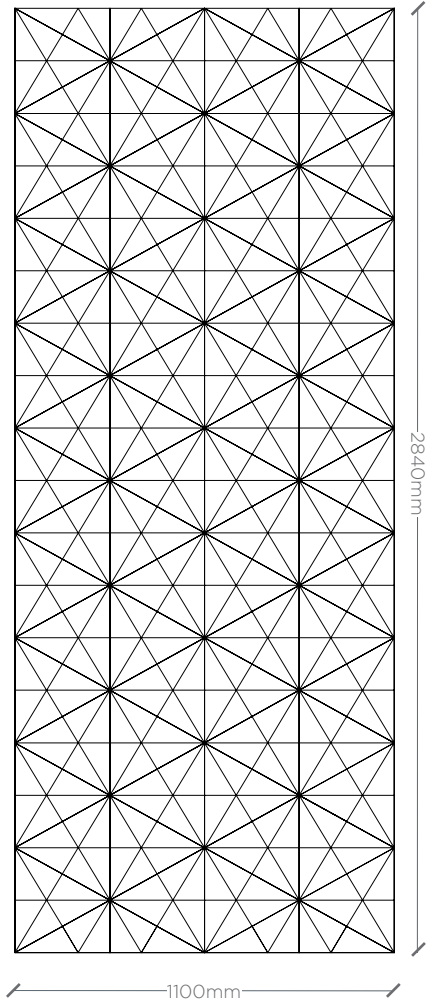

L





AVAILABLE MATERIALS

-  ULTRA MATT LAMINATE
-  ULTRA THIN RECONSTITUTED WOOD

-  BIRCH
-  OKUMÈ
-  MDF COLOR

-  ULTRA MATT LAMINATE
-  ULTRA THIN RECONSTITUTED WOOD
-  SYNTHETIC FELT

-  BIRCH
-  OKUMÈ
-  MDF COLOR

-  ULTRA MATT LAMINATE
-  ULTRA THIN RECONSTITUTED WOOD
-  SYNTHETIC FELT



S

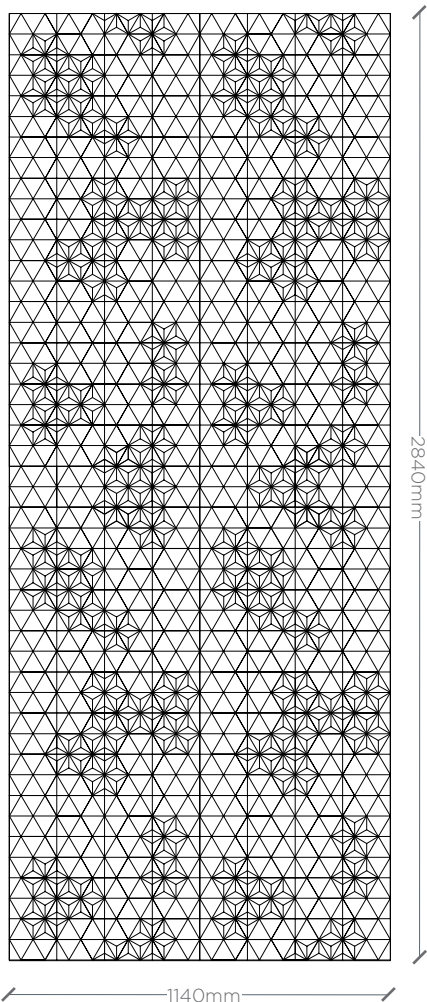

M

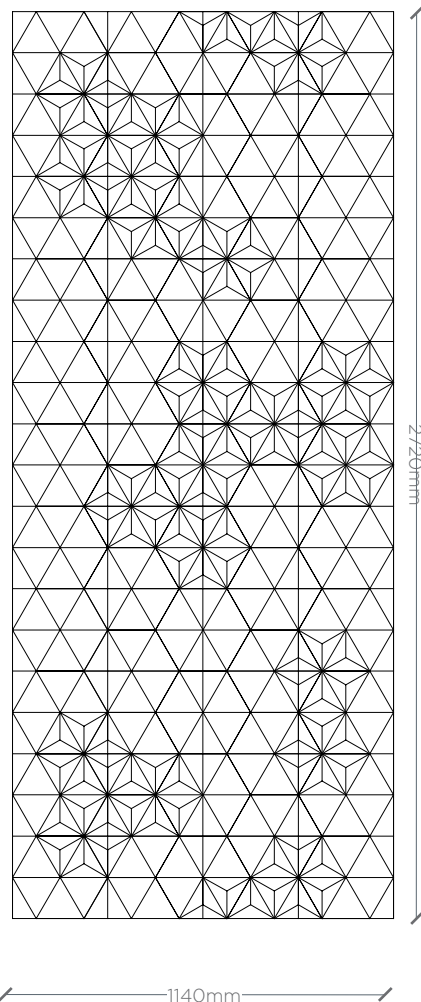

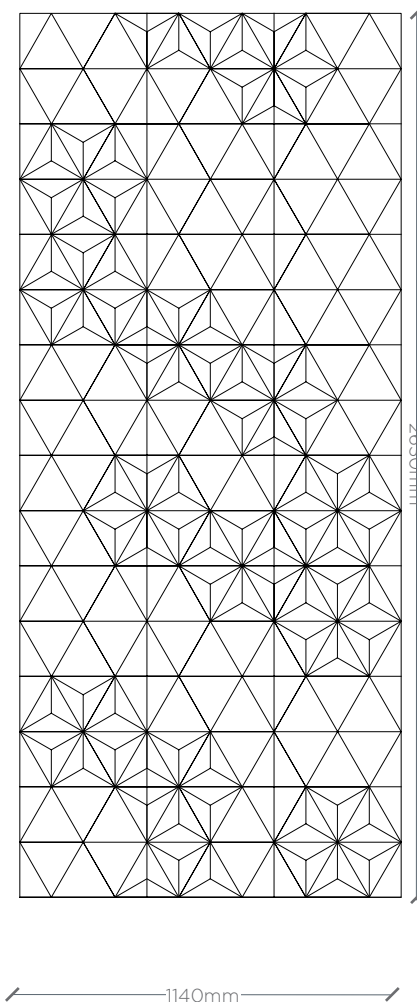

L





AVAILABLE MATERIALS

-  ULTRA MATT LAMINATE
-  ULTRA THIN RECONSTITUTED WOOD

-  BIRCH
-  OKUMÉ
-  MDF COLOR

-  ULTRA MATT LAMINATE
-  ULTRA THIN RECONSTITUTED WOOD
-  SYNTHETIC FELT

-  BIRCH
-  OKUMÉ
-  MDF COLOR

-  ULTRA MATT LAMINATE
-  ULTRA THIN RECONSTITUTED WOOD
-  SYNTHETIC FELT

PATTERN SUMMARY

CLASSIC

A



S

M

L

B



M

L

C



S

M

L

BASIC

A



S

M

L

B



M

C



M

L

DIGITAL

A



M

L

B



S

M

L

DECOR

A



S

M

L

B

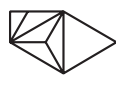

S

M

L

MATERIALS

GROUP 1 ASTME 84 - FIRE REATED MATERIAL AVAILABLE UPON REQUEST

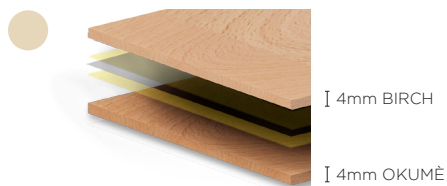

NAME: BIRCH
 CHARACTERISTICS:
 High quality aesthetic and strutturale performance - light color with amber hue
 FINISHES AVAILABLE:
 • veneer
 • laminate
 • clear coat
 COLORS AVAILABLE UPON REQUEST

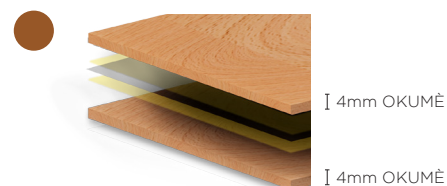

NAME: OKUMÉ
 CHARACTERISTICS:
 high quality plywood with low density - flamed, warm hue
 FINISHES AVAILABLE:
 • veneer
 • laminate
 • clear coat
 COLORS AVAILABLE UPON REQUEST

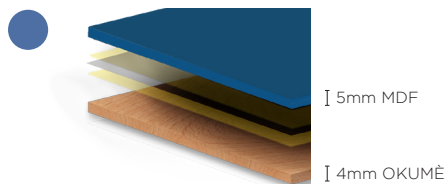

NAME: COLORED MDF
 CHARACTERISTICS:
 Recommended for low-stress applications or temporary installations - wide range of colors possibilities - combined with sophisticated finishes, moderately hydrophobic
 FINISHES AVAILABLE:
 • veneer
 • laminate
 • clear coat
 COLORS AVAILABLE UPON REQUEST

GROUP 2 ASTME 84 - FIRE REATED MATERIAL AVAILABLE UPON REQUEST

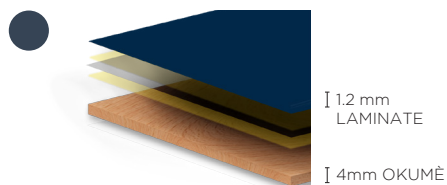

NAME: ULTRA MATT LAMINATE
 CHARACTERISTICS:
 an innovative nanotech material for interior design: a smart, extremely matt, anti-fingerprint, very resistant, soft touch surface.
 COLORS AVAILABLE UPON REQUEST

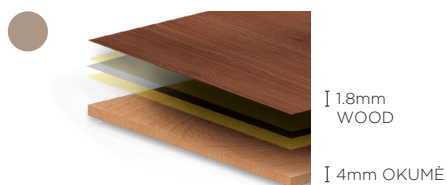

NAME: ULTRA -THIN RECONSTRUCTED WOOD
 CHARACTERISTICS:
 High quality and aesthetic
 COLORS AVAILABLE UPON REQUEST

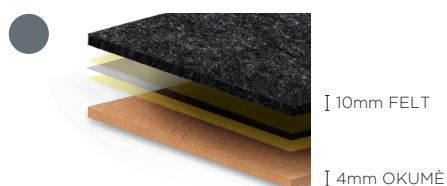

NAME: SYNTHETIC FELT
 CHARACTERISTICS:
 The acoustically highly effective fibre-reinforced composite ensures a high level of sound absorption, even with a low material thickness.
 AVAILABLE COLORS:

All compositions with Okumé back side - Net prices indicating net area covered with smooth 3D effect - Ex works - Vat excluded if applicable - Hardware, packaging and shipping excluded

HARDWARE & INSTALLATION

WALL

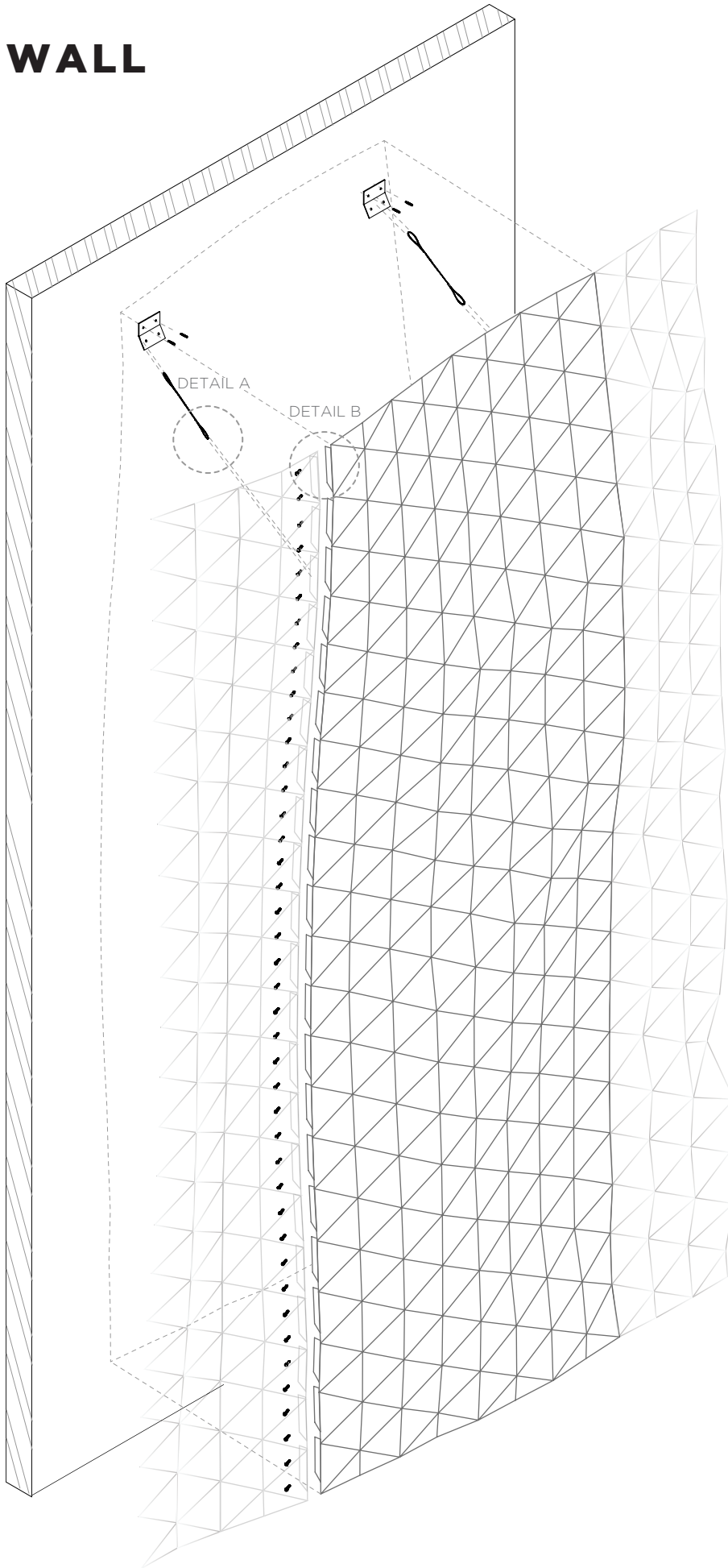

DETAIL A

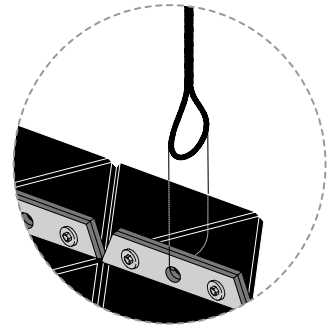

DETAIL B

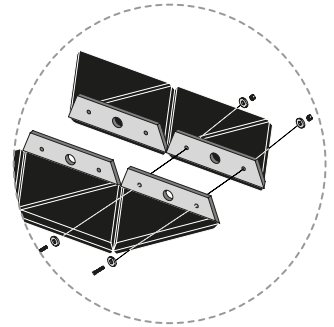

CEILING

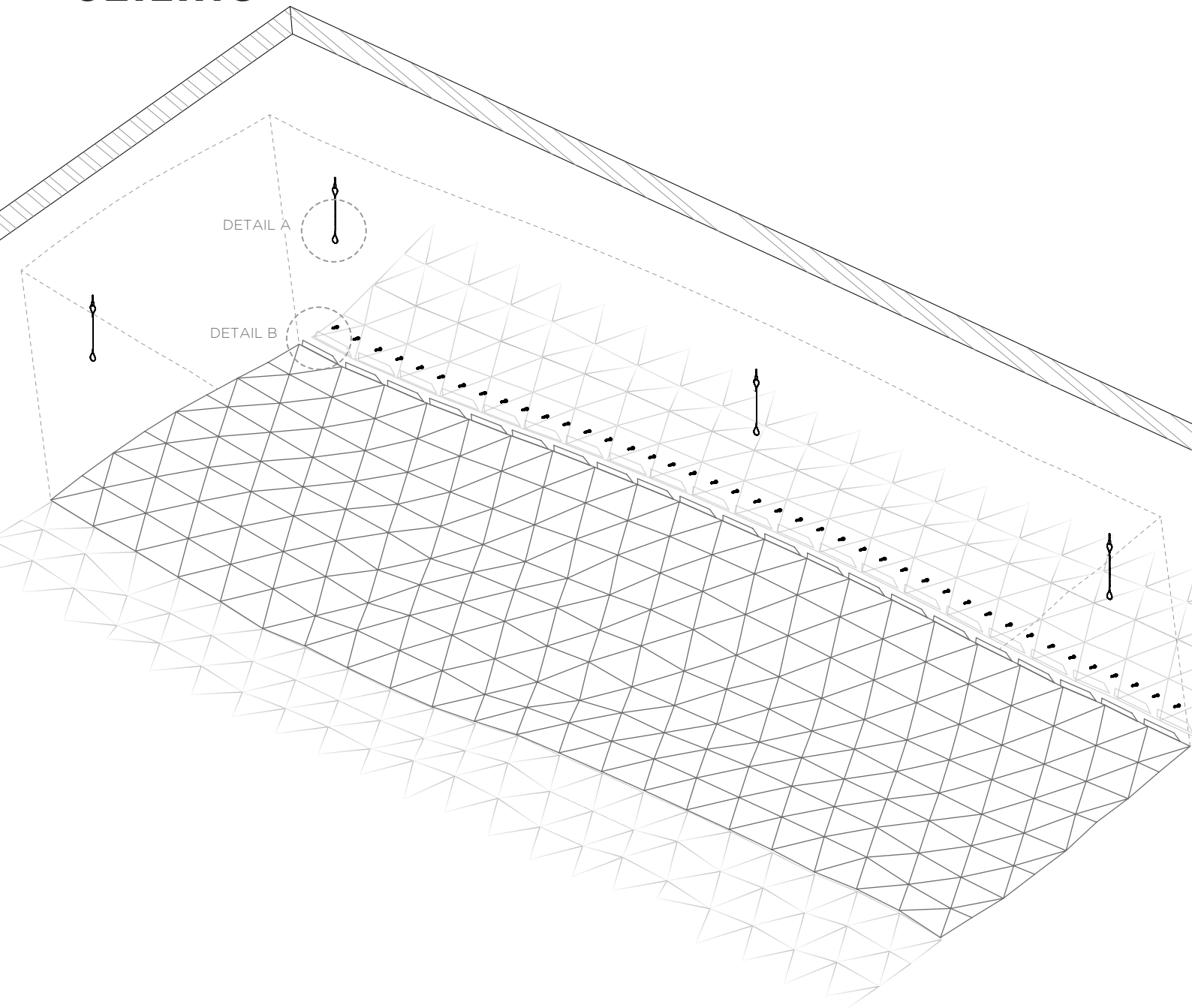

DETAIL A

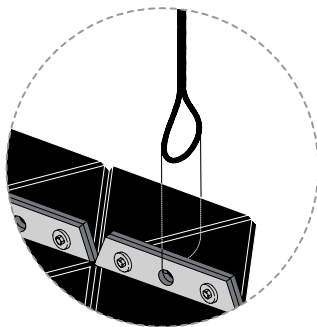

DETAIL B

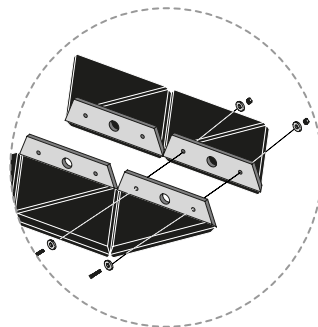

INSTALLATION GUIDELINES

The Mesh Sheets ceiling system requires only few anchoring points, thanks to its semi-rigid membrane nature the sheets behave.

The standard solution uses certified metal wires with a quick tensioning system to connect the wooden flaps on the WOOD-SKIN® to the ceiling.

Depending on the existing conditions, the wire will be anchored either to a standard metal grid fixed to the slab or directly to the ceiling with the related fixture.

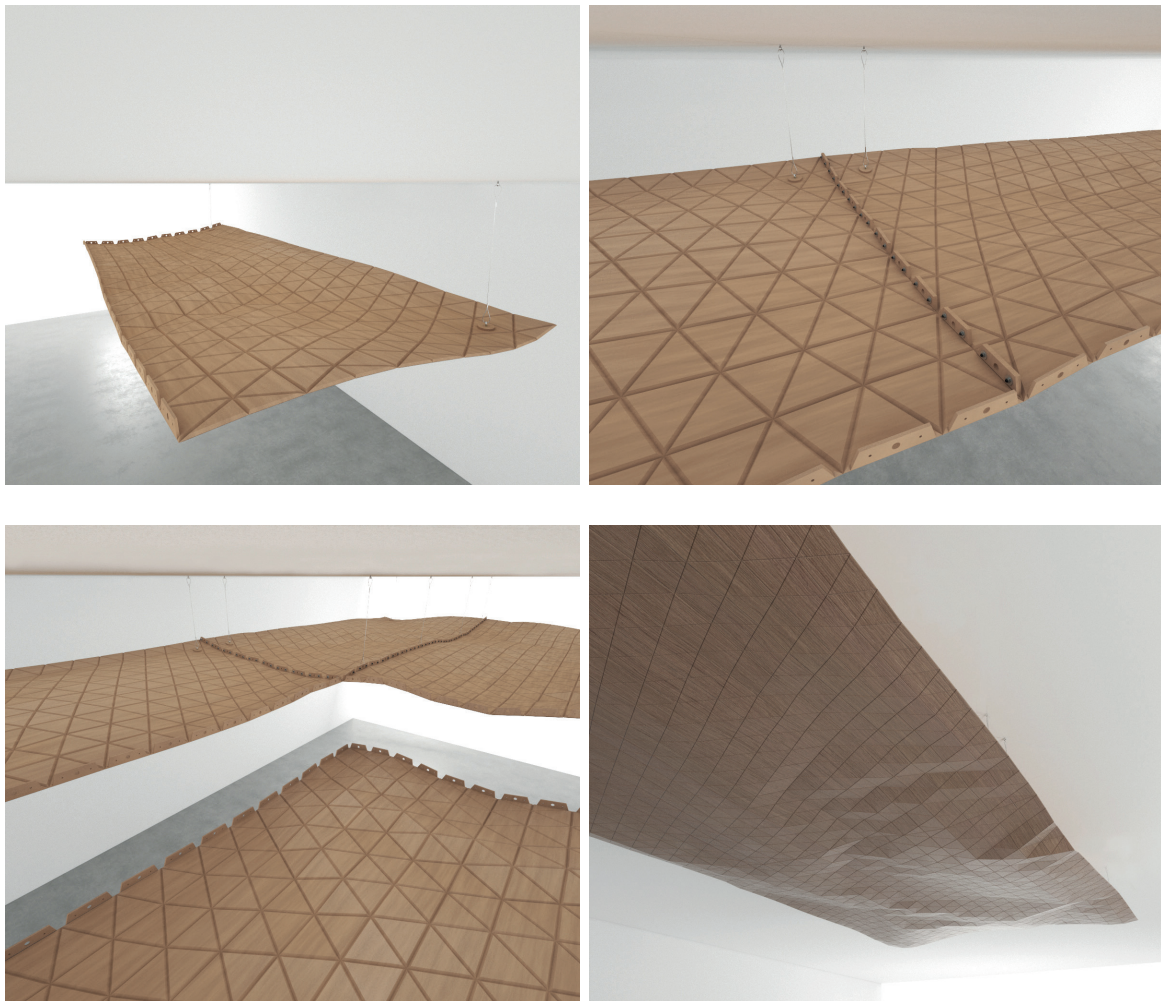

ADDITIONAL CUSTOMIZATIONS

CUSTOM CUTOUTS

LIGHTS



SCREENS



ELECTRIC



HOLES

ENGRAVING

GEOMETRIC



DRAWING



PATTERN

DIMENSIONS



NEW PATTERN

